

行程:12mm

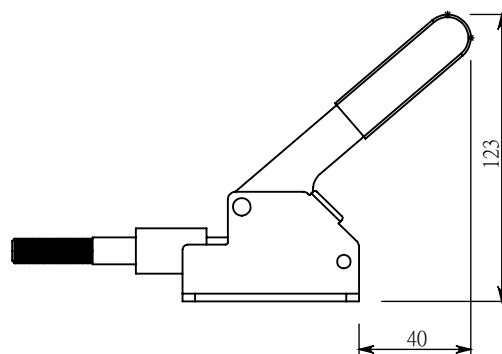
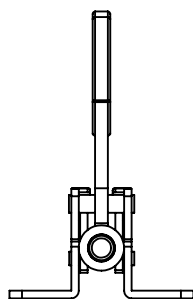
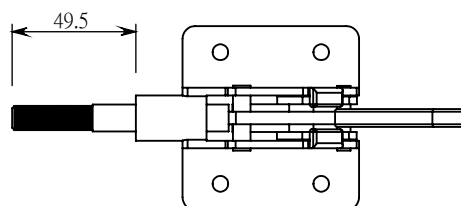
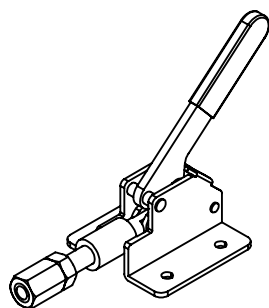
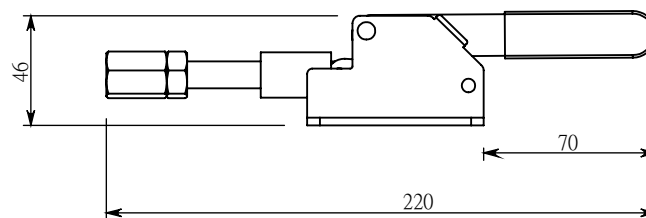
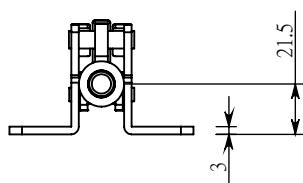
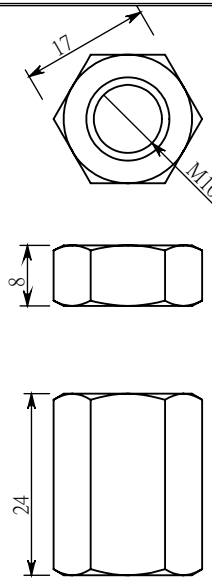
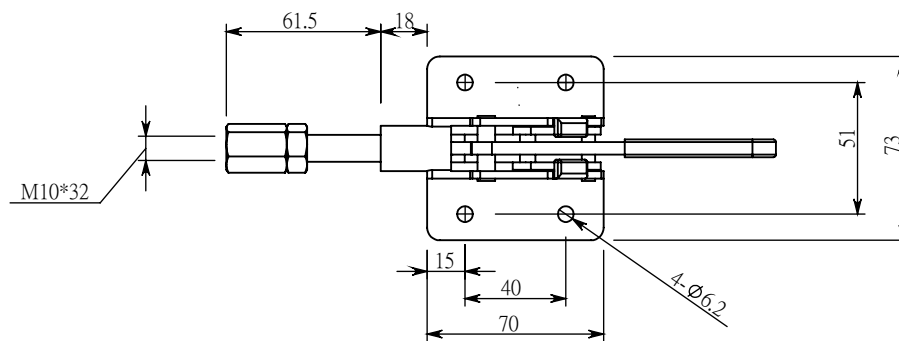

KD-302DM

圖名: 組合作件1		圖號:
單位:mm	材質:	日期:2013/2/22